



## ASSEMBLY INSTRUCTIONS

- CHECK THE NUMBER OF PACKAGES (PARTS) RECEIVED AGAINST THE BILL OF LADING. IF ANY SHORTAGES, SECURE A "SHORTAGE NOTATION" FROM THE CARRIER AND FILE A CLAIM. CHECK MATERIAL FOR DAMAGE. IF ANY IS DAMAGED, SECURE A "DAMAGED NOTATION" FROM THE CARRIER AND FILE A CLAIM AGAINST CARRIER.
- CHECK MATERIAL RECEIVED AGAINST YOUR "COPY OR ORDER".
- WHEN UNPACKING, ARRANGE LIKE PARTS TOGETHER AND AS CLOSE AS POSSIBLE TO WORKING AREA IN WHICH THEY ARE TO BE ASSEMBLED.
- TOOLS REQUIRED ARE A RUBBER Mallet AND A SCREW DRIVER WHEN USING CENTER SUPPORTS.
- FAMILIARIZE YOURSELF WITH ALL COMPONENT PARTS.
- SAVE THIS DOCUMENT FOR FUTURE REFERENCE.

WHEN INSERTING BEAMS INTO SLOTS ON POST, BEAMS MUST BE SEATED INTO BOTTOM OF SLOTS WITH A RUBBER Mallet

- START BY PUTTING SIDE FRAME ASSEMBLIES TOGETHER BY INSERTING FRONT TO BACK BEAMS (PART SB/HB) INTO POST.
- ONCE BOTH SIDE FRAME ASSEMBLIES ARE MADE, TAKE ONE SIDE FRAME ASSEMBLY AND INSERT ONE LEFT TO RIGHT ANGLE BEAM (SB/HB) INTO THE BOTTOM OF FRONT POST AND ONE LEFT TO RIGHT BEAM INTO THE BOTTOM OF THE REAR POST. THIS WILL MAKE THE FRAME STAND UP BY ITSELF. NOW INSERT THE OPPOSITE END OF THE SAME LEFT TO RIGHT BEAMS (SB/HB) INTO THE OTHER FRAME ASSEMBLY.
- NOW WITH THE UNIT STANDING, INSERT ADDITIONAL SHELVES REQUIRED TO COMPLETE UNIT.
- ASSEMBLE CENTER SUPPORTS (IF REQUIRED) TO ANGLE BEAMS AND/OR CHANNEL BEAMS USING (4) 10-24 x 5/8 BOLTS AND WING NUTS PER SUPPORT.
- ASSEMBLE ARCHIVES BOX SUPPORTS (IF REQUIRED) TO BEAMS USING TWO PLASTIC BUTTONS PER SUPPORT.
- ASSEMBLE FOOT PLATE (IF REQUIRED) TO POST USING ONE OR TWO (AS REQUIRED) TEK SCREWS. ANCHOR TO FLOOR (ANCHORS NOT SUPPLIED BY PENCO).
- ATTACH TIE PLATES (IF REQUIRED) BY INSERTING RIVETS IN POST AND TAP DOWN TO SEAT.
- ASSEMBLE ROW SPACERS AND TOP TIES (IF REQUIRED) BY INSERTING RIVETS INTO THE FACE OF THE POSTS OPPOSITE EACH OTHER AND TAP TO SEAT.
- ASSEMBLE WALL TIES (AS REQUIRED) INTO THE FACE OF THE POST AND ANCHOR THE OPPOSITE END TO THE WALL.
- ASSEMBLE POST SPLICE TO BOTTOM AND TOP ANGLE POST USING 8 BOLTS AND 8 NUTS. WHEN USING T POST USE TWO POST SPLICES AND ATTACH TO BOTTOM AND TOP POST USING 12 BOLTS AND 12 NUTS. NOTE: BEAMS CANNOT BE PLACED IN THE LEVEL OCCUPIED BY THE SPLICE.

# SINGLE RIVET UNITS

## Starter and Add-On

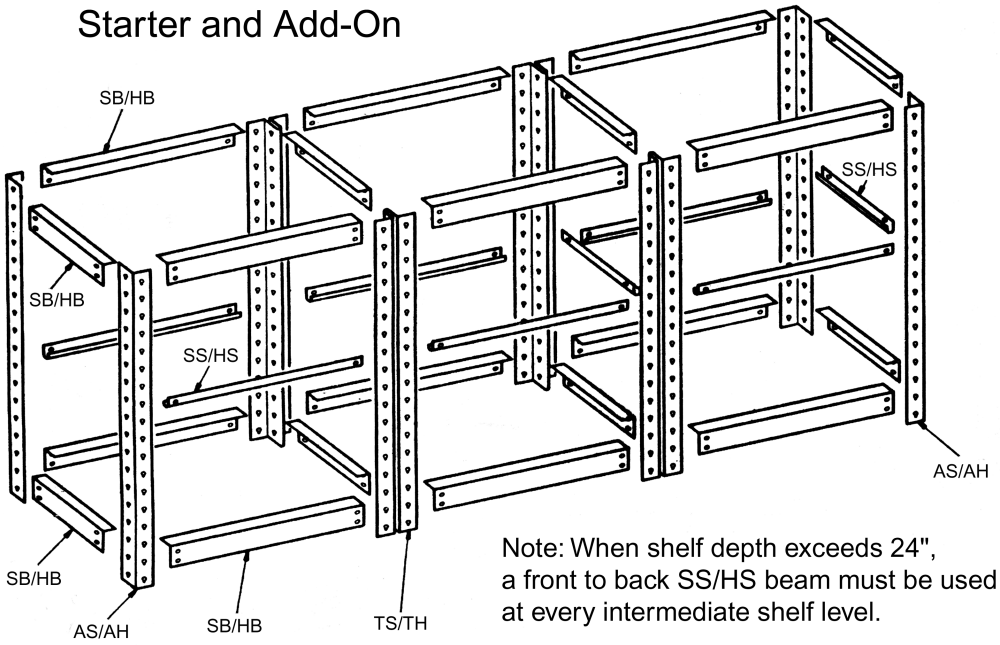

Note: When shelf depth exceeds 24", a front to back SS/HS beam must be used at every intermediate shelf level.

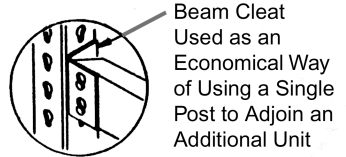
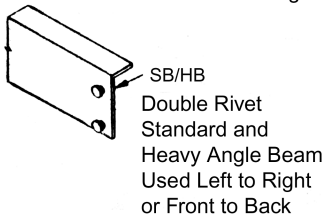
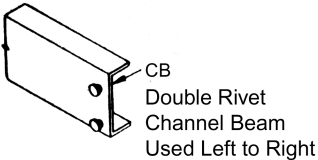
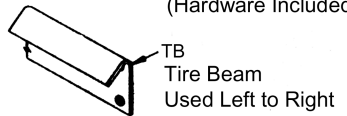
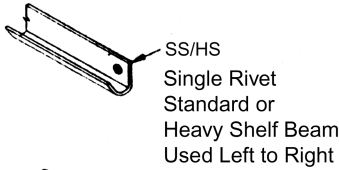
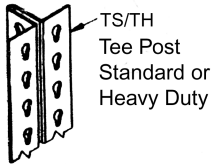
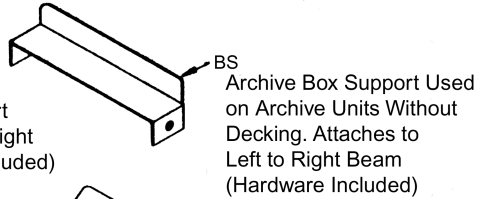
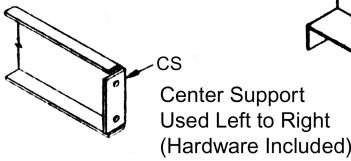
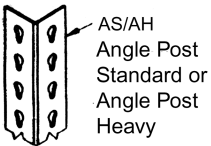

# DOUBLE RIVET UNITS

## Starter and Add-On

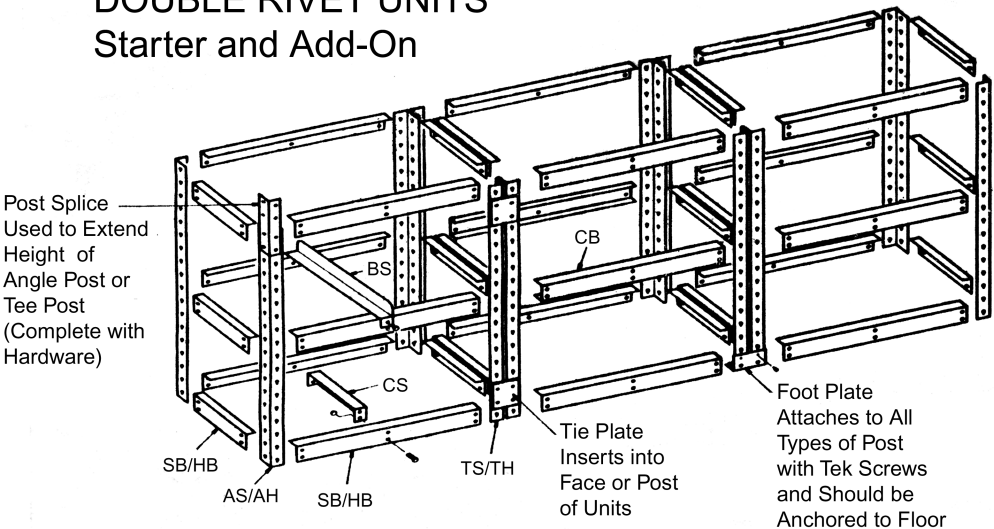

Post Splice  
Used to Extend  
Height of  
Angle Post or  
Tee Post  
(Complete with  
Hardware)

Foot Plate  
Attaches to All  
Types of Post  
with Tek Screws  
and Should be  
Anchored to Floor